



# **CERTIFIER40G**

## **Fiber Certification Testing**

User Manual

## Certifier Series (C40G)



## Notices

No part of this manual may be reproduced in any form or by any means (including electronic storage and retrieval or translation into a foreign language) without prior agreement and written consent from Viavi Solutions as governed by international copyright Laws.

## Warranty

The material contained in this document is provided “as is,” and is subject to being changed, without notice, in future editions. Further, to the maximum extent permitted by applicable law, disclaims all warranties, either express or implied, with regard to this manual and any information contained herein, including but not limited to the implied warranties of merchantability and fitness for a particular purpose. Viavi Solutions shall not be liable for errors or for incidental or consequential damages in connection with the furnishing, use, or performance of this document or of any information contained herein. Should Viavi Solutions and the user have a separate written agreement with warranty terms covering the material in this document that conflict with these Terms, the warranty terms in the separate agreement shall control.



### WARNING

A CAUTION notice denotes a hazard.

It calls attention to an operating procedure, practice, or the like that, if not correctly performed or adhered to, could result in damage to the product or loss of important data. Do not proceed beyond a CAUTION notice until the indicated conditions are fully understood and met.



### CAUTION

Operating procedure, practice, if not correctly performed or adhered to, could result in personal injury or death. Do not proceed beyond a WARNING notice until the indicated conditions are fully understood and met.

## General Safety Information



### WARNING

Do not use the device if it is damaged. Before you use the device, inspect the casing. Look for cracks or missing plastic. Do not operate the device around explosive gas, vapor, or dust.

Always use the device with the cables provided.

Observe all markings on the device before establishing any connection.

When servicing the device, use only the specified replacement parts.

Do not operate the device with the cover removed or loosened.

Use only the power adapter provided by the manufacturer to avoid any unexpected hazards.



### CAUTION

If the device is used in a manner not specified by the manufacturer, the device protection may be impaired.

Always use dry cloth to clean the device. Do not use ethyl alcohol or any other volatile liquid to clean the device.

Do not permit any blockage of the ventilation holes of the device.

## Environmental Conditions

This instrument is designed for indoor use and in an area with low condensation. The table below shows the general environmental requirements for this instrument

---

Environmental conditions	Requirements
Operating Temperature	0 °C to 40 °C
Operating humidity	20% to 85% RH non-condensing
Relative humidity	10% to 80%

---

### NOTE

The CERTIFIER40G, CERTIFIER10G complies with the following Safety and Regulatory requirements.

DIN EN 55024, Edition:2003-10 (IEC/CISPR 24:1997, modified + A1:2001 + A2:2002); EN 55024:1998 + A1:2001 + A2:2003

DIN EN 55022; VDE 0878-22:2008-05 (IEC/CISPR 22:2005, modified + A1:2005); EN 55022:2006 + A1:2007

---

## Regulatory Markings



The CE mark is a registered trademark of the European Community. This CE mark shows that the product complies with all the relevant European Legal Directives.

# Declaration of Conformity



Manufacturer's Name

Psiber Data Pte. Ltd

Manufacturer's Address

3 Science Park Drive #03-08,  
The Franklin Singapore Science Park 1,  
Singapore 118223

Declares under sole responsibility that the product as originally delivered

Description

Cable Certification Tester Kit

Equipment

Cable Certifier

Complies with the essential requirements of the following applicable European Directives and carries the CE marking accordingly:

DIN EN 55024, Edition:2003-10 (IEC/CISPR 24:1997, modified + A1:2001 + A2:2002); EN 55024:1998 + A1:2001 + A2:2003

DIN EN 55022;

VDE 0878-22:2008-05 (IEC/CISPR 22:2005, modified + A1:2005);

EN 55022:2006 + A1:2007

Signature

Arvind C Patel

[www.psiberdata.com](http://www.psiberdata.com)

Date :

December 14, 2010

## Contents

<b>Chapter 1: Getting Started</b> .....	<b>8</b>
Unpacking the box.....	8
<b>Chapter 2: Configuring Certifier</b> .....	<b>10</b>
Certifier User Interface.....	10
Touch Screen Layout.....	10
The One Touch Access Buttons .....	12
<b>Chapter 3: Setting Reference</b> .....	<b>21</b>
<b>Chapter 4: Configuring an AUTOTEST</b> .....	<b>30</b>
Testing Guide for Dual-Ended Testing .....	31
Testing Guide for Single-Ended Loopback Testing.....	32
<b>Chapter 5: Performing an AUTOTEST</b> .....	<b>34</b>
Managing test result(s) .....	35
Exporting test results into J-Report PC Software.....	36

## Chapter 1: Getting Started

### Unpacking the box

#### Single Mode Fiber



Single Mode Adapters



SC-SC Duplex Reference Cords  
Mating Coupler

#### Multi Mode Fiber



Multi Mode Adapters



SC-SC Duplex Reference Cords  
Mating Coupler



## Encircled Flux Compliant Multi Mode Fiber



**EF Compliant MM Adapters**



**FC-SC Modally Transparent  
Reference Cords SC-SC Tail  
Cords  
Mating Coupler**

Optional SM/MM/MMEF LC Cord Kits available.

## Chapter 2: Configuring Certifier

### Certifier User Interface

#### *Touch Screen Layout*

The Graphical User Interface (GUI) in version 7.0's firmware has been updated with a more responsive system and quick-access menus.

Certifier boots up to the SETUP screen. It is categorised into 5 groups:

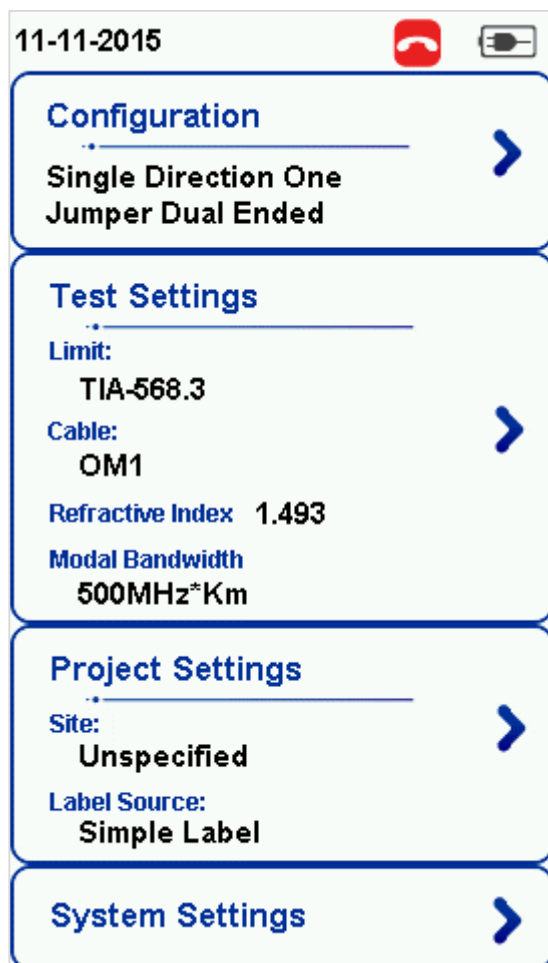

1. Status bar
2. Configuration group
3. Test Settings group
4. Project Settings group
5. System Settings group



1. The **Status bar** displays the current date, talk set and battery level.
2. The **Configuration** group provides selection on number of jumper(s) referencing is set to, and determine single or bi-directional test is performed during an AUTOTEST.
3. The **Test Settings** group provides results oriented configurations necessary to perform an AUTOTEST.
4. The **Project Settings** group provides non-results oriented configurations before performing an AUTOTEST.
5. The **System Settings** group settings provides device, time, localization and device related configurations. The Information group at the top provides hardware information such as the device Information (Local/Remote), name, battery level, etc.

### **The One Touch Access Buttons**

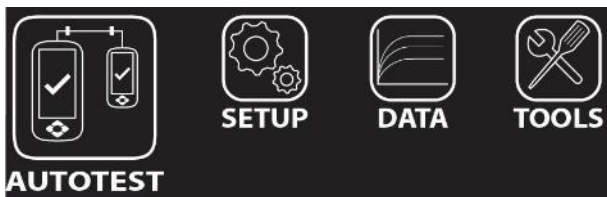

The fundamental philosophy behind the Certifier User Interface is simplicity in its ease of use. The main functions of the One-Touch access buttons as follows:

#### AUTOTEST



The “**AUTOTEST**” button will perform an immediate certification test on the last configured settings. If no settings were configured, default settings will be used.

Test results will be generated automatically after the test is completed.

You will receive any of the following 4 results after the “**AUTOTEST**”:



- Green “**PASS**” – Good test result in accordance to pre-defined settings.



- Red “**FAIL**” – Unacceptable results with severe disturbance on one or more test parameters.

You will be given the following option after performing an AUTOTEST:

- “**Save**” test results to device

An “**AUTOTEST**” will fail in the event of missing connection between the Local and Remote units, wrong settings configured, “dirty” end connectors or broken cables.

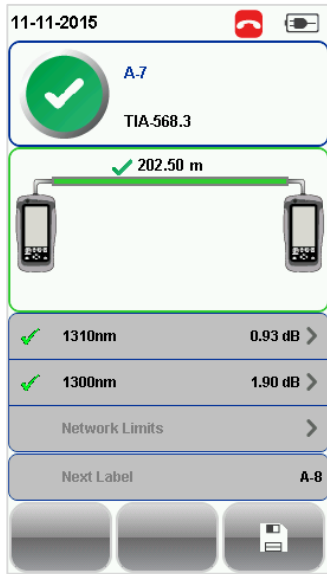

SM Fiber AUTOTEST results

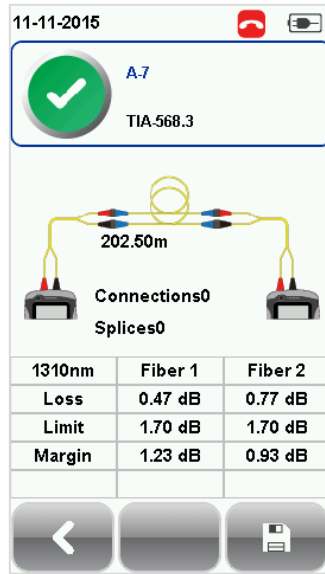

Detailed results for 1310nm

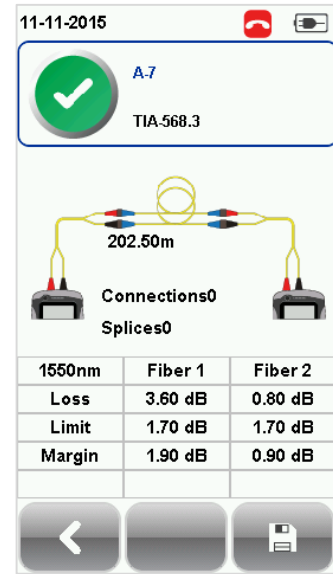

Detailed results for 1550nm

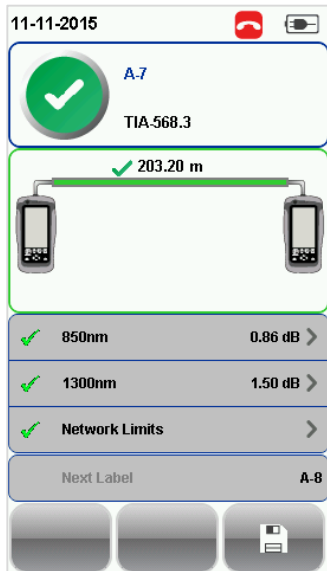

MM Fiber AUTOTEST results

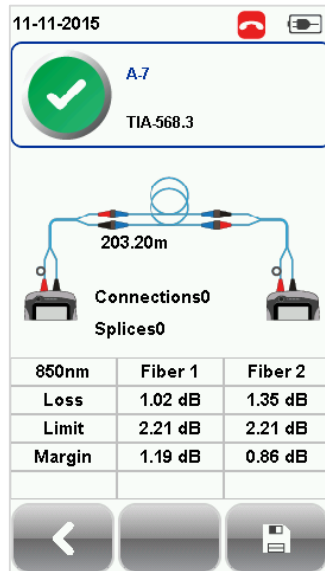

Detailed results for 850nm

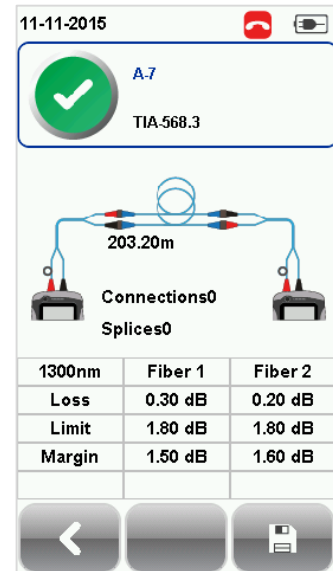

Detailed results for 1310nm

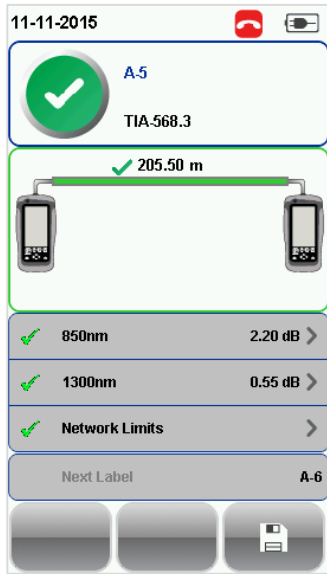

MMEF Fiber AUTOTEST results

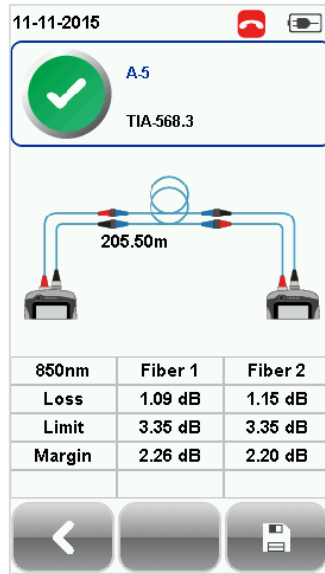

Detailed results for 850nm

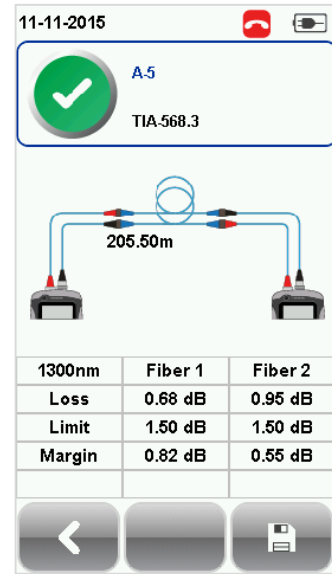

Detailed results for 1300nm

If Bi-direction is selected, swap the TX and RX connections on both ends when prompted.

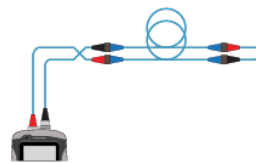
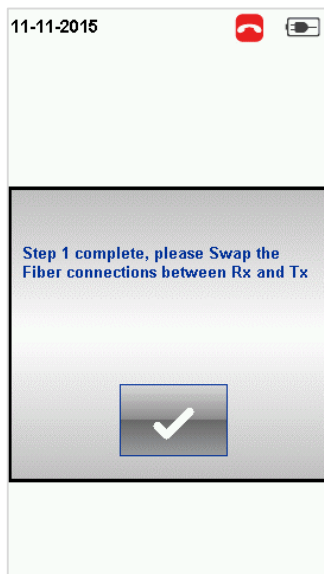

Swapping of TX and RX for Single-ended loopback testing.

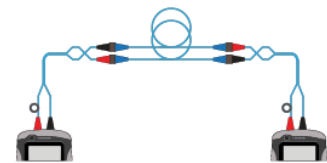

Swapping of TX and RX for Dual-ended testing.

## SETUP



The “**SETUP**” button provides setting options necessary to conduct an AUTOTEST and configure the device.

These options include –

### Configuration

**Configuration** provides selection of the number of jumper(s) is used for setting reference on dual or single ended loopback, and determines if single or bi-directional test is performed during an AUTOTEST.

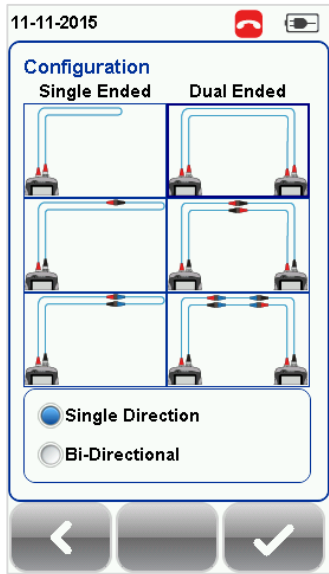

1 Jumper, Single-ended



1 Jumper, Dual-ended



2 Jumpers, Single-ended

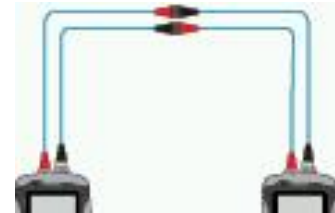

2 Jumpers, Dual-ended

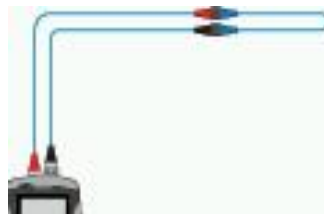

3 Jumpers, Single-ended

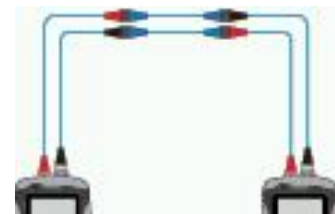

3 Jumpers, Dual-ended

## NOTE

According to the ISO/IEC standards, the 2-jumpers testing method is not compliant, hence the selection for 2-jumpers configuration will be disabled when an ISO limit is selected.

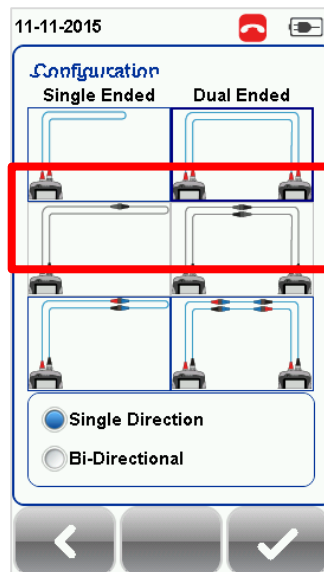

## Test Settings

Test Settings provides results oriented configurations necessary to perform an AUTOTEST.

### Test Limit

Standard Limits: Choose from a list of standards to determine the performance criteria in a given standard. Tab to change the value for number of connections, loss per connection, number of splices and loss per splice.

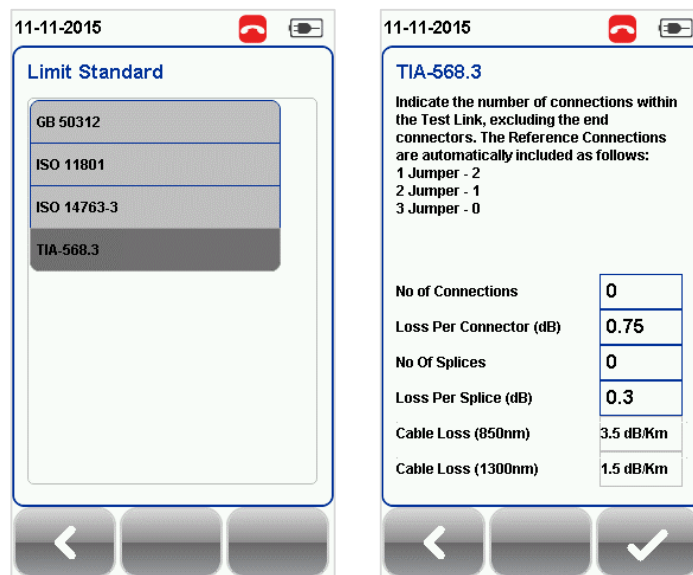

Network Limits: Choose from a list of network limits to determine additional specific network testing criteria such as maximum loss in link validation, Ethernet standard, fiber channel or custom limits. Custom limits can be created using spreadsheet software, saved as \*.CSV format and loaded to the device.

Length Limits: Enter fiber length if test criteria requires specific fiber length.





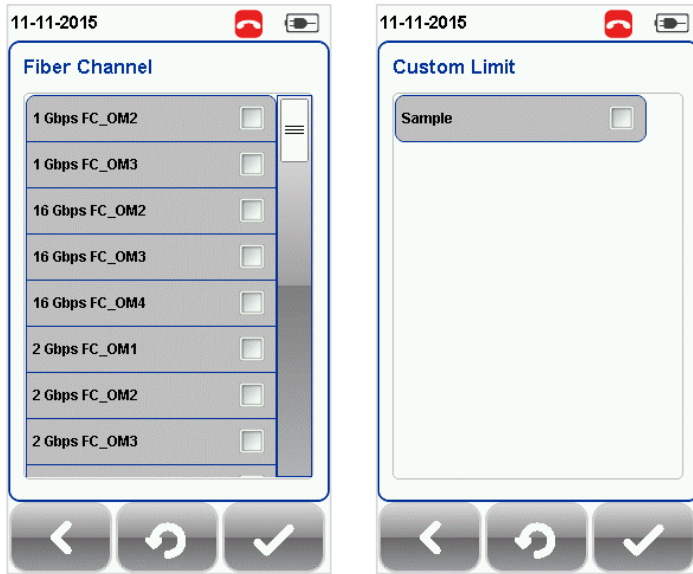

### Cable

Press the SETUP button > Test Settings > Cable to choose from a list of cable manufacturers. If unsure of manufacturer, choose “Generic SMF” or “Generic MMF”, or “Customised Cable” to create custom cable.

Click “Add” to add or “Manage” to remove customised cable(s) from the customised cable list.

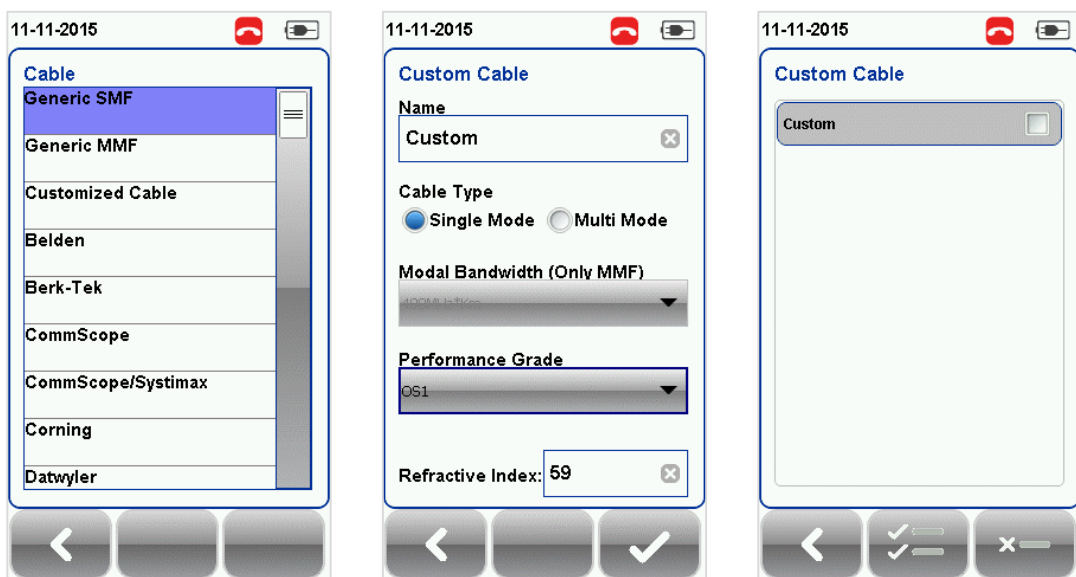

Add customised cable

Manage customised cables

When creating customised cable, determining the cable name, cable type, performance grade and cable’s refractive index is required.



Certifier introduces the “**Manage**” button on version 7.0 firmware. “Manage” enables multiple saved items such as sites,

operators, customized cables, customized connectors and results to be selected and deleted simultaneously.

### Refractive Index

The refractive index determines the speed light is travelling in the fiber optic. The value is determined by the fiber cable selected.

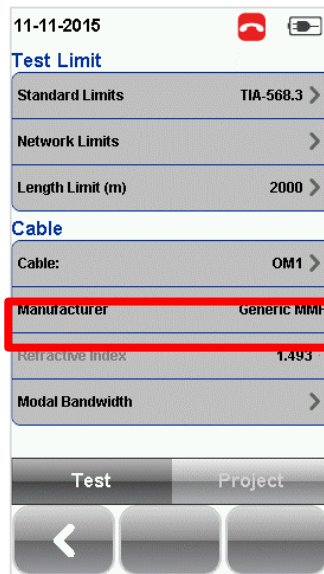

### Modal Bandwidth

Press the SETUP button > Test Settings > Modal Bandwidth to choose the modal bandwidth of the cable under test. Modal bandwidth refers to the signalling rate per distance unit. Select 400MHz\*Km for OM1 (62.5/125), 500MHz\*Km for OM2 (50/125), 2000MHz\*Km for OM3 (50/125) and 4700MHz\*Km for OM4 (50/125).

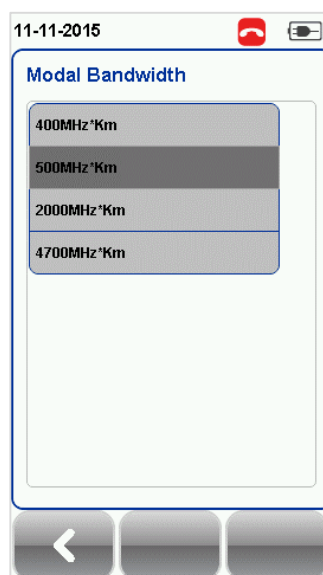

## Project Settings

Project Settings provides non-results oriented configurations before performing an AUTOTEST.

Refer to *User Manual – Certifier Copper Certification* for more information on Project Settings.

### *Label Source*

Refer to *User Manual – Certifier Copper Certification* or *User Guide – List Based Testing* for more information.

### *List Based Testing*

List based testing allows creation of label list in the J-Report software on PC and then bring the list to Certifier. It further allows easy selection of labels from the list to help technician select the cables to be tested quickly. This testing method is carefully optimized for typical test work-flow, and it significantly improves productivity.

Refer to *User Manual – Certifier Copper Certification* or *User Guide – List Based Testing* for more information.

## System Settings

### *Device Type*



Press the SETUP button > System Settings 1 > Device Settings > Device Type to set unit as a Local or Remote unit. Device will reboot to take effect.

Refer to *User Manual – Certifier Copper Certification* for more information on System Settings.

## DATA



The “**DATA**” button provides archive and data management ability to saved sites and test results. Saved test results can be renamed or deleted in this option.

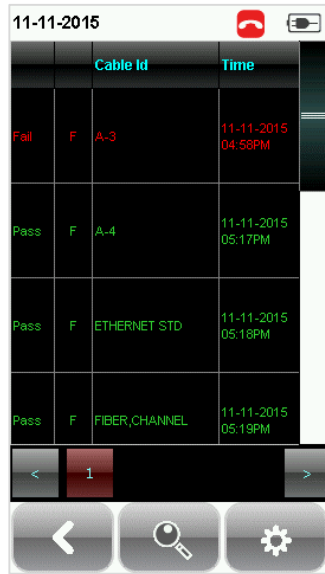
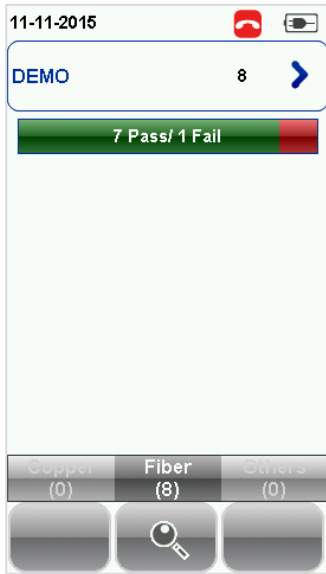

View results

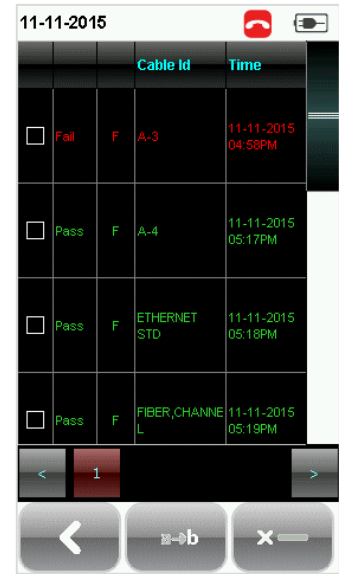

Manage results

## TOOLS



The “**TOOLS**” button provides advanced options for in-depth troubleshooting and advanced Certifier users. These options include-



Requires:  
Local and Remote

**Set Reference** – Establish test conditions and exclude the reference cords from the measurement.



Requires:  
Local and Remote

**Power Meter** – Measures the power loss from a 850/1300nm or 1310/1550nm wavelength light source.



Requires:  
Local or Remote

**Light Source** – Emits 850/1300nm or 1310/1550nm light source to determine loss on a Power Meter.



Requires:  
1. Local or Remote  
2. Inspection Probe

**Inspect Fiber** – Performs visual verification of fiber’s quality using an external scope probe.



Requires:  
Local or Remote  
(MMEF only)

**VFL** – Visual Fault Locator. Emits light for visual detection of broken fiber location.



Requires:  
1. Local MM/MMEF  
2. Remote MPO

**MPO/MTP** – Switches device to MPO mode to perform single fiber Power Meter test.



Requires:  
Local or Remote

**About** – Displays worldwide contact information.

## Chapter 3: Setting Reference

It is necessary to perform a set reference measurement at the beginning of a job, whenever the test fiber is disconnected from the transmitter, and whenever a reference verification fails.

The setup varies depending on the number of jumpers reference is selected.

***Following procedures are only for MMEF, MM and SM fiber.***

For 1 jumper dual-ended,

1. Connect FC1 to the Local TX port and SC1 to the Remote RX port.
2. Connect FC2 to the Remote TX port and SC2 to Local RX port.



3. Press the SETUP button > Testing Configuration and select “One Jumper” from Dual-Ended column. Select Single or Bi direction depending on requirement.
4. Press the TOOLS button > Set Reference and press the “ok” button to set reference.

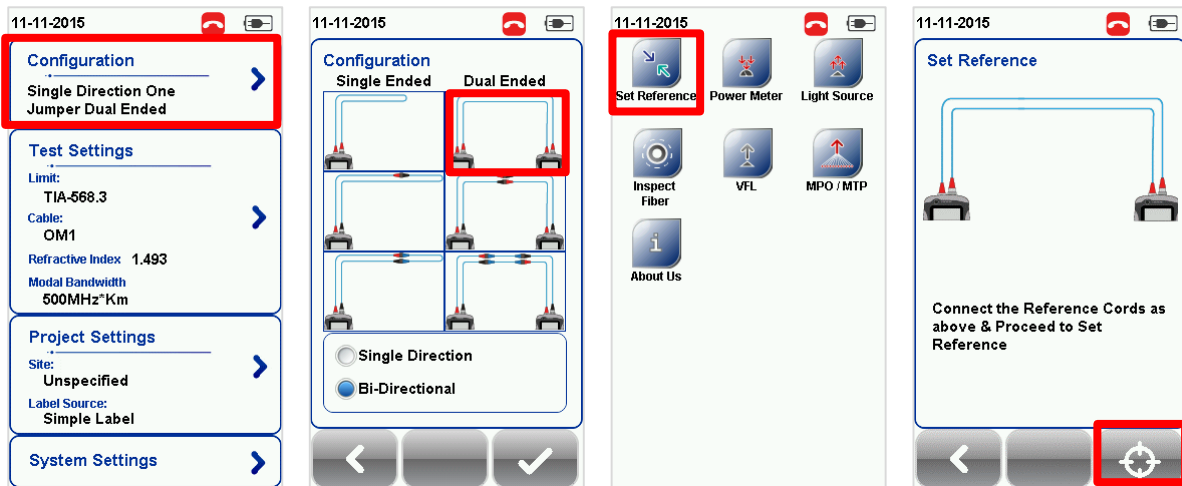

5. Check that the Set Reference result is  $\leq 0.15$  dB before proceeding. Clean or replace reference cords if necessary, and set reference again if value exceeds 0.15 dB.

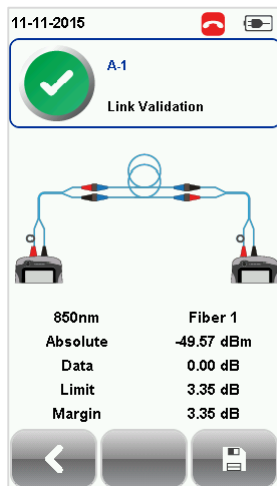

### Verification Test

To verify reference has been set correctly, setup the following connection.

1. Connect FC1 to the Local TX port and SC1 to coupler 1.
2. Connect SC5 to the Local RX port and SC6 to coupler 2.
3. Connect FC2 to the Remote TX port and SC2 to coupler 2.

4. Connect SC3 to the Remote RX port and SC4 to coupler 1.

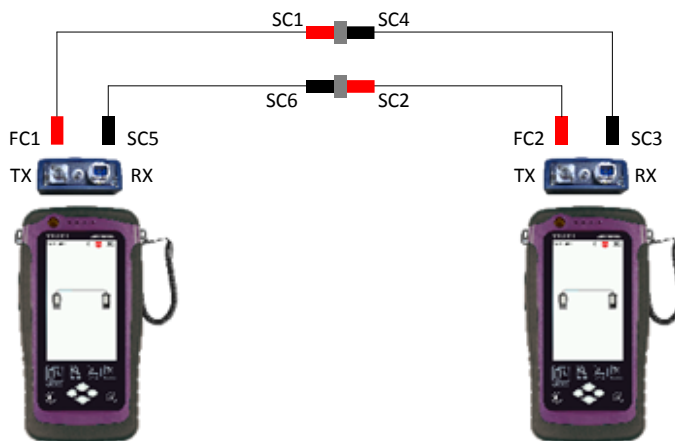

5. Press the AUTOTEST button.
6. Check that the result passes with the following results;
  - Single Mode – 0.2 dB
  - Multi-Mode - 0.1 dB
  - EF compliant Multi-mode – 0.1 dB

For 2 jumpers dual-ended,

1. Connect FC1 to the Local TX port and SC1 to coupler 1.
2. Connect SC5 to the Local RX port and SC6 to coupler 2.
3. Connect FC2 to the Remote TX port and SC2 to coupler 2.
4. Connect SC3 to the Remote RX port and SC4 to coupler 1.

Please ensure the fiber cables are cleaned using the cleaning kit provided in the kit.

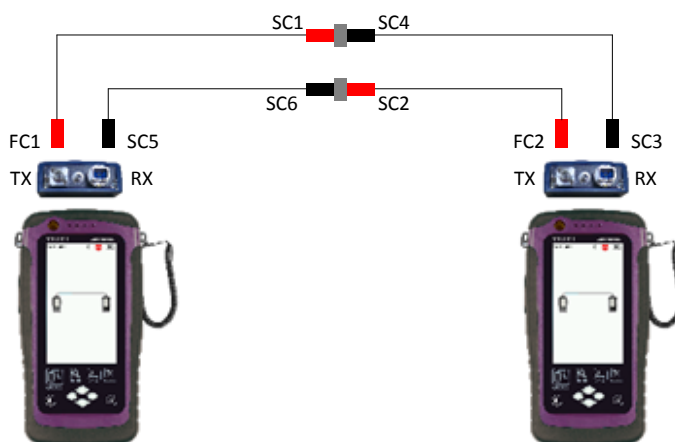

5. Press the SETUP button > Testing Configuration and select “Two Jumper” from Dual-Ended column. Select Single or Bi direction depending on requirement.

6. Press the TOOLS button > Set Reference and press the “ok” button to begin set reference.

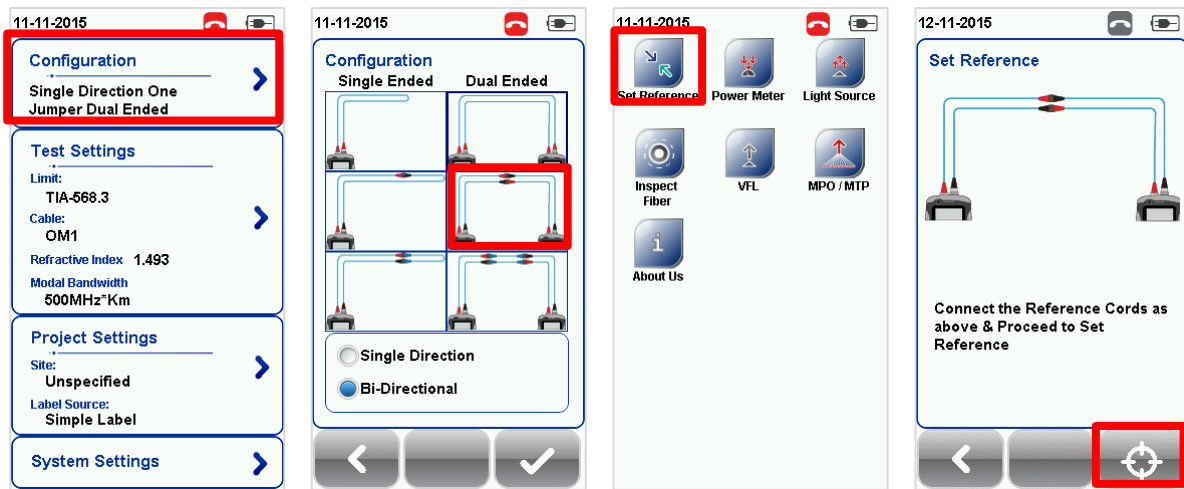

7. Check that the Set Reference result is  $\leq 0.15$  dB before proceeding. Clean or replace reference cords if necessary, and set reference again if value exceeds 0.15 dB.



For 3 jumpers dual-ended,

1. Connect FC1 to the Local TX port and SC1 to coupler 1.
2. Connect SC5 to the Local RX port and SC6 to coupler 2.
3. Connect FC2 to the Remote TX port and SC2 to coupler 4.
4. Connect SC3 to the Remote RX port and SC4 to coupler 3.
5. Connect your jumper's SC end SC7 to coupler 1 and SC8 to coupler 3.
6. Connect your jumper's SC end SC9 to coupler 2 and SC10 to coupler 4.

Please ensure the fiber cables are cleaned using the cleaning kit provided in the kit.

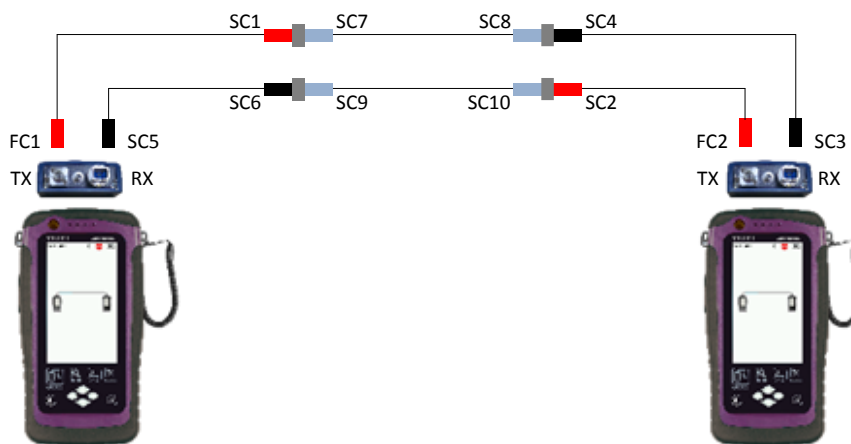

7. Press the SETUP button > Testing Settings > Reference Method and select "Three Jumper" in the Remote Unit.
8. Press the TOOLS button > Set Reference and press the "ok" button to begin set reference.

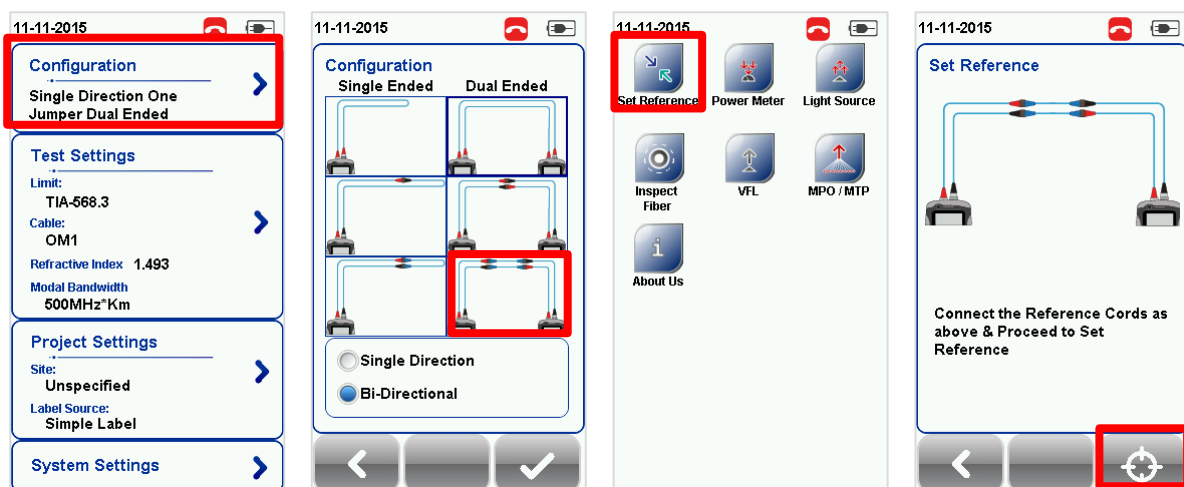

9. Check that the Set Reference result is  $\leq 0.15$  dB before proceeding. Clean or replace reference cords if necessary, and set reference again if value exceeds 0.15 dB.

For 1 jumper single-ended loopback,

1. Connect the FC and SC ends of the reference cord to the TX port RX port of the adapter respectively.

Please ensure the fiber cables are cleaned using the cleaning kit provided in the kit.

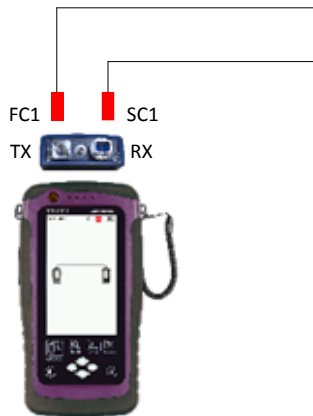

2. Press the SETUP button > Testing Configuration and select “One Jumper” from Single-Ended column. Select Single or Bi direction depending on requirement.
3. Press the TOOLS button > Set Reference and press the “ok” button to begin set reference.

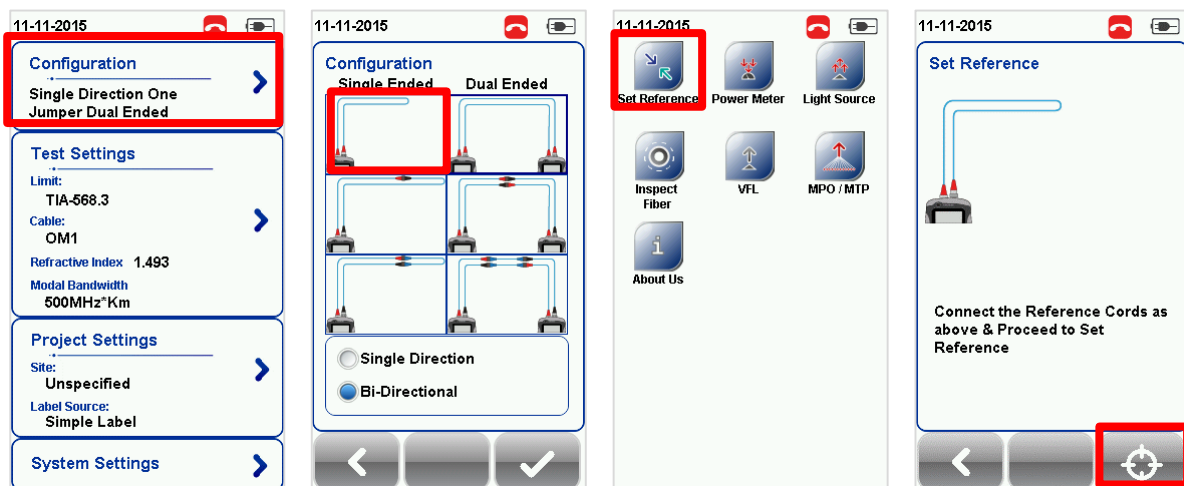

4. Check that the Set Reference result is  $\leq 0.15$  dB before proceeding. Clean or replace reference cords if necessary, and set reference again if value exceeds 0.15 dB.

For 2 jumpers single-ended loopback,

1. Connect FC1 to the TX port and SC1 to a SC coupler.
2. Connect SC2 to the RX port and SC3 to the coupler.

Please ensure the fiber cables are cleaned using the cleaning kit provided in the kit.

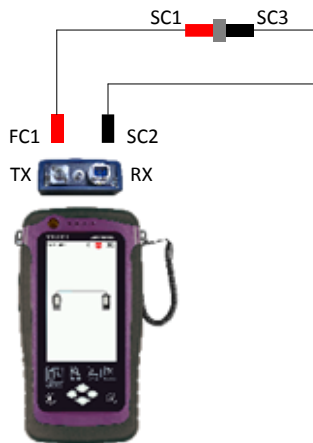

3. Press the SETUP button > Testing Configuration and select “Two Jumper” from Single-Ended column. Select Single or Bi direction depending on requirement.
4. Press the TOOLS button > Set Reference and press the “ok” button to begin set reference.

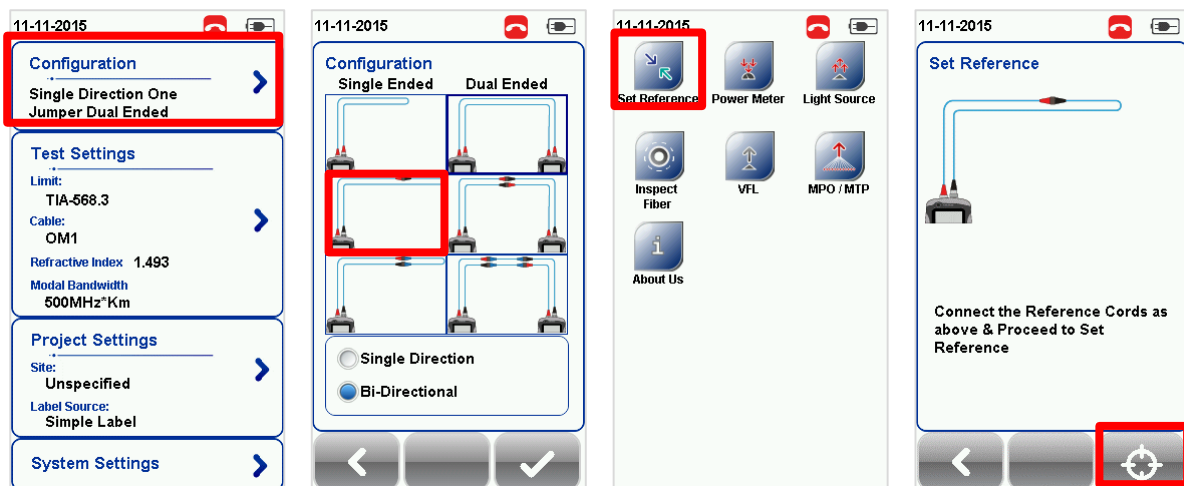

5. Check that the Set Reference result is  $\leq 0.15$  dB before proceeding. Clean or replace reference cords if necessary, and set reference again if value exceeds 0.15 dB.

For 3 jumpers single-ended loopback,

1. Connect FC1 to the TX port and SC1 to a SC coupler 1.
2. Connect SC2 to the RX port and SC3 to another coupler 2.
3. Connect your jumper's SC end SC4 to coupler 1 and SC5 to coupler 2.

Please ensure the fiber cables are cleaned using the cleaning kit provided in the kit.



4. Press the SETUP button > Testing Configuration and select "Two Jumper" from Single-Ended column. Select Single or Bi direction depending on requirement.
5. Press the TOOLS button > Set Reference and press the "ok" button to begin set reference.

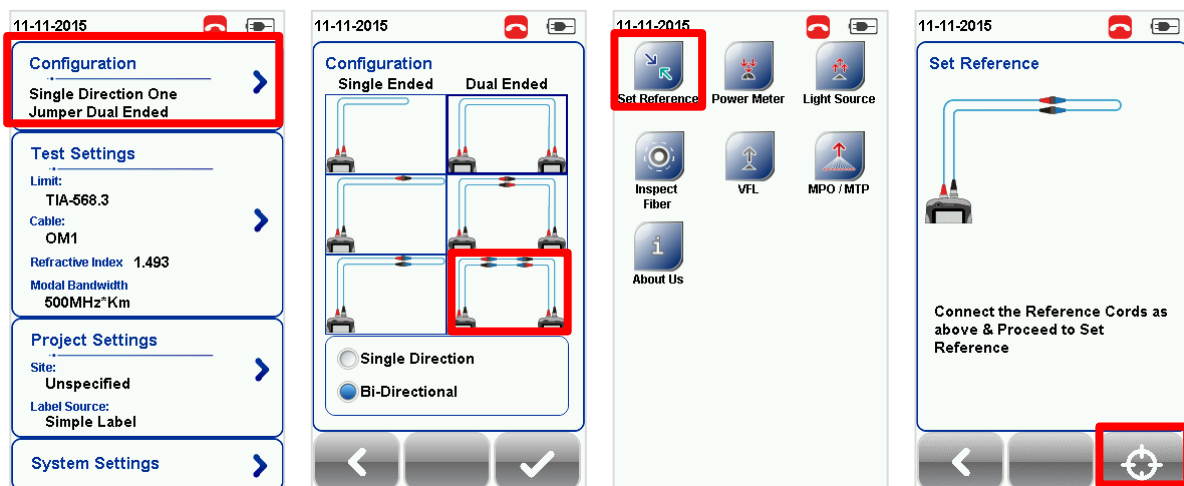

6. Check that the Set Reference result is  $\leq 0.15$  dB before proceeding. Clean or replace reference cords if necessary, and set reference again if value exceeds 0.15 dB.

Set Reference will fail in the event of-

- Adapter probe mismatch
- Firmware version mismatch
- No connection between Local and Remote units

#### NOTE

According to the ISO/IEC standards, the 2-jumpers testing method is not a recognised procedure, hence the selection for 2-jumpers configuration will be disabled when an ISO limit is selected.

## Chapter 4: Configuring an AUTOTEST

After configuring the system settings, follow these steps to set up an AUTOTEST.

1. Press the SETUP button > Project Settings
  - a. **Site** – Create or select a Site
  - b. **Operator** – Create or select an Operator
  - c. **Label Source** – Select cable labelling scheme. Load labels from USB flash drive if using List Based Testing (LBT).
  - d. **AutoSave** – Enable option for Certifier to auto save every PASS result.
2. Press the SETUP button > Test Settings
  - a. **Test Limit** – Select a test limit
  - b. **Cable** – Create a custom or select cable from list. Select “Generic” if unsure.
  - c. **Modal Bandwidth** - Choose the modal bandwidth of the cable under test. Leave option unchanged if unsure.

Please ensure you have the following components before conducting the test;

- Certifier, Local & Remote units
- Single Mode Testing Kit OR
- Multi-Mode Testing Kit OR
- Encircled Flux Multi-Mode Testing Kit



Single Mode Testing Kit



Multi-Mode Testing Kit



EF Multi-Mode Testing Kit

## Testing Guide for Dual-Ended Testing

1. Connect FC1 to the Local TX port and SC1 to coupler 1.
2. Connect SC5 to the Local RX port and SC6 to coupler 2.
3. Connect FC2 to the Remote TX port and SC2 to coupler 4.
4. Connect SC3 to the Remote RX port and SC4 to coupler 3.
5. Connect the cord to be tested SC7 to coupler 1 and SC8 to coupler 3.
6. Connect the other cord to be tested SC9 to coupler 2 and SC10 to coupler 4.

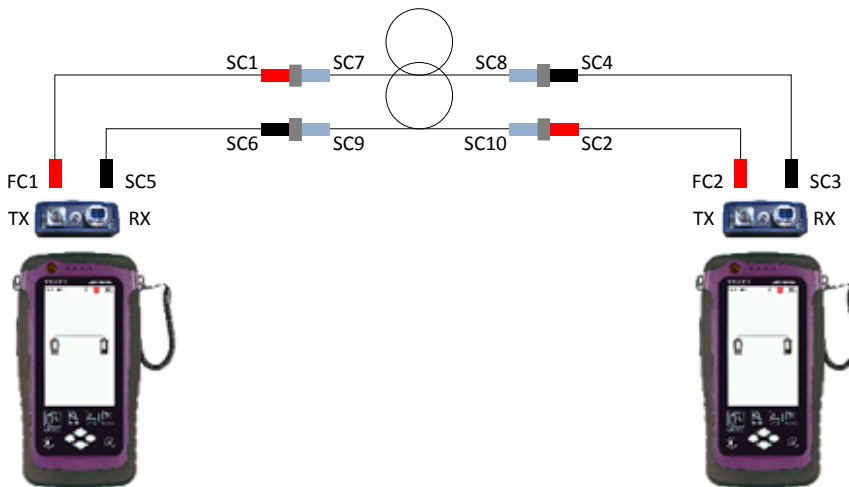

7. Press the AUTOTEST button to begin AUTOTEST.
8. If Bi-Direction measurement is selected, swap the position of SC1 and SC6, SC2 and SC4.

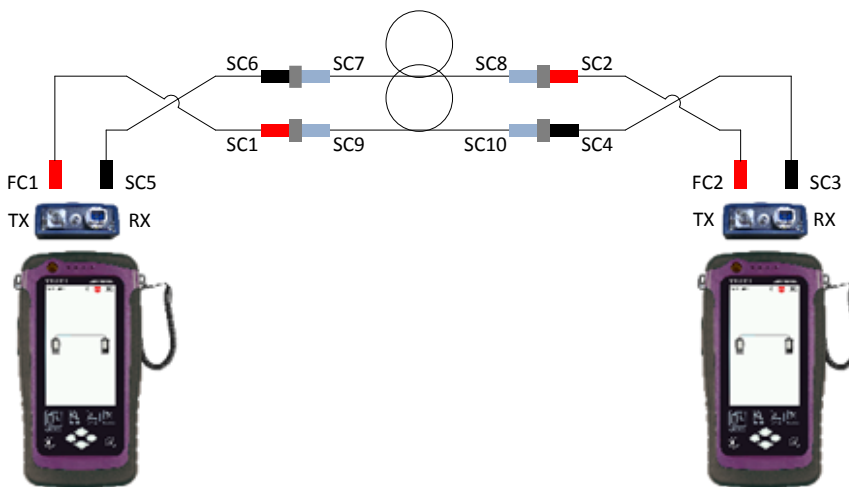

9. Click "Step 2" to continue test.

10. Select “850nm” or “1300nm” for Multi-mode or “1310nm” or “1550nm” for Single Mode to check the Loss, Limit and Margin of the fiber setup at the respective wavelength.

## Testing Guide for Single-Ended Loopback Testing

1. Connect FC1 to the Local TX port and SC1 to coupler 1.
2. Connect SC2 to the Local RX port and SC3 to coupler 2.
3. Connect SC4 to coupler 3 and SC5 to coupler 4.
4. Connect the cord to tested SC6 to coupler 1 and SC7 to coupler 3.
5. Connect the other cord to be tested SC8 to coupler 2 and SC9 to coupler 4.

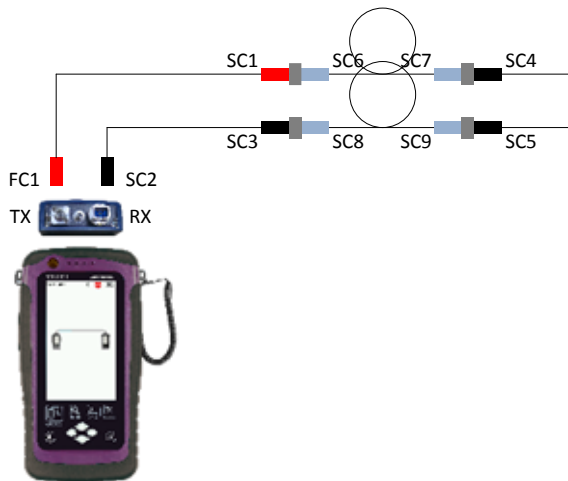

6. Press the AUTOTEST button to begin AUTOTEST.
7. If Bi-Direction measurement is selected, swap the position of SC1 and SC3.

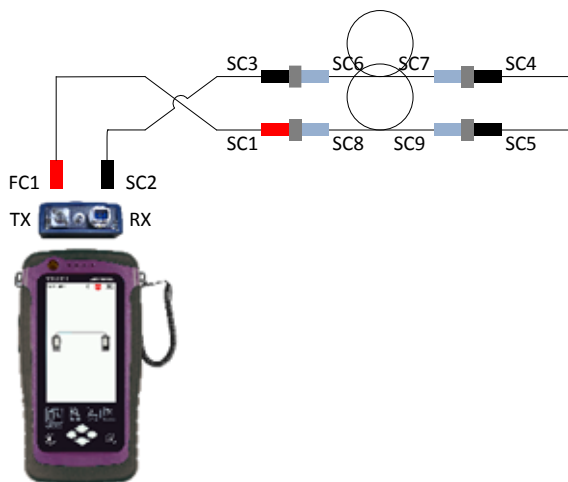

8. Click “Step 2” to continue test.



9. Select "850nm Margin" or "1310nm Margin" to check the Loss, Limit and Margin of the fiber setup at the respective wavelength.

## Chapter 5: Performing an AUTOTEST

Press the AUTOTEST button once settings and limits have been selected. Certifier will use the last configuration or factory settings to perform the AUTOTEST if new settings are not configured.

Certifier will display summarized result with PASS or FAIL once AUTOTEST is completed. Press the “View” details button to view the comprehensive result or the “Save” button to save the results.

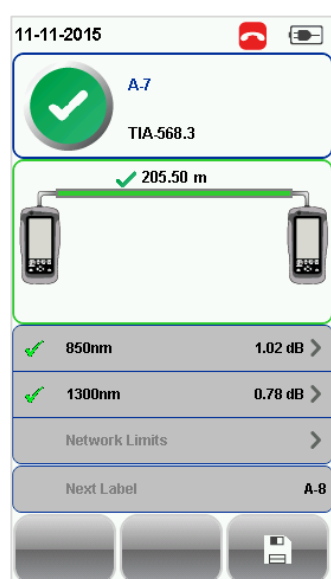

*AUTOTEST overview*

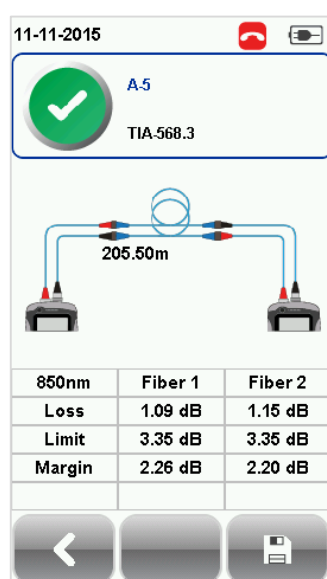

*Detailed view for Single directional test*

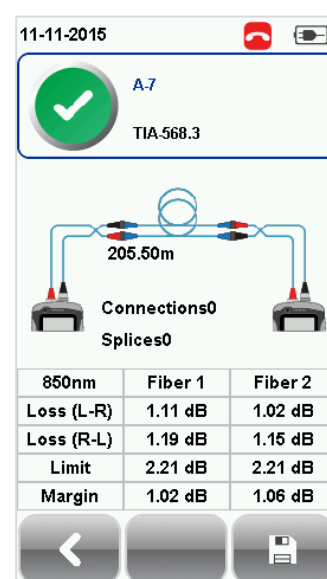

*Detailed view for Bi-directional test*

Click on the parameter to display a more comprehensive individual result.

In detailed view, loss from the Local to the Remote unit, Limit and Margin will be displayed for each wavelength for both Single and Multi-mode. If Bi-directional test is selected at the configuration settings, test result for loss from Remote to Local will be displayed.

Depending on installation requirements, additional application test standards will be performed during an Autotest if Ethernet Standard and/or Fiber Channel is selected. To perform additional application standard test, press the SETUP button > Test Settings > Network Limits.

Certifier will perform a separate test based on the loss value input if Link Validation is selected.

## Managing test result(s)

Test results can be manually saved by pressing the “Save” button after an AUTOTEST is completed. When prompted, enter label name and click “OK” to save.

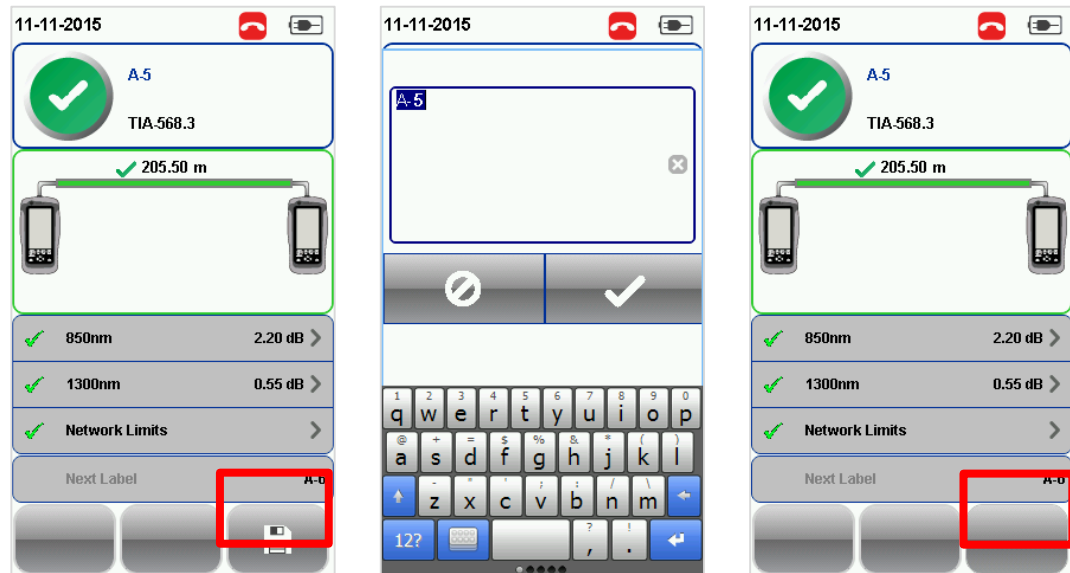

*The “Save” icon will disappear once saving is completed.*

To view saved results,

1. Press the “DATA” button.
2. Select “Fiber” and press the “View” button.
3. Select the test results click “View” button to view results.
4. Select next page for more results.

To delete a saved result,

1. Press the “DATA” button.
2. Select “Fiber” and press the “View” button.
3. Press the “Manage” button.
4. Select result(s) and press the “Delete” button to delete result(s).

To rename a saved result,

1. Press the “DATA” button.
2. Select “Fiber” and press the “View” button.
3. Press the “Manage” button.
4. Select result and press the “Rename” button to rename result.

## Exporting test results into J-Report PC Software

Refer to *User Manual – Certifier Copper Certification* for more information on exporting test results into J-Report PC Software.

Refer *User Manual – J-Report* for more information on how to use the software.